



FEATURES

- Suitable for triggering most medium and high power thyratrons.
- Triggered by either optical or low-level electrical trigger input signal.

DESCRIPTION

The MA2709A is designed as a trigger generator for most medium and high power thyratrons. It can be triggered by either a low-level electrical signal into the BNC connector or via an optical signal into the FSMA connector. The maximum working frequency is 1 kHz.

The MA2709A can provide a maximum grid 1 pre-ionising current pulse of 45 A (determined by the external grid 1 drive resistor) from a nominal 500 V drive voltage, together with a nominal 1 kV grid 2 trigger pulse (with -150 V bias) from an 80 Ω source, delayed from the grid 1 pulse by 0.5 μs. Grid 1 and grid 2 outputs are via SHV BNC connectors.

The unit has Transient Voltage Suppressors (TVSs) fitted internally but it is important that additional TVS protection, as described on page 2, is fitted close to the thyratron being triggered, and that the mains input is filtered and protected from voltage spikes. The earthing of the unit should follow good practice.

With the additional external TVS protection, the unit has been shown to withstand 20 kV, 100 ns spikes at the grid 1 and grid 2 outputs without damage.

e2v technologies limited, Waterhouse Lane, Chelmsford, Essex CM1 2QU England Telephone: +44 (0)1245 493493 Facsimile: +44 (0)1245 492492
e-mail: enquiries@e2vtechnologies.com Internet: www.e2vtechnologies.com Holding Company: e2v holdings limited

e2v technologies inc. 4 Westchester Plaza, PO Box 1482, Elmsford, NY10523-1482 USA Telephone: (914) 592-6050 Facsimile: (914) 592-5148
e-mail: enquiries@e2vtechnologies.us

© e2v technologies limited 2004

GENERAL DATA

Electrical

Input voltage (AC rms) (see note 1)	115 ± 10% V or 230 ± 10% V
Input power	50 VA

Mechanical (See Fig. 3)

Length	320 mm
Width:	
including feet	280 mm
without feet	240 mm
Height (including 4 mm feet and terminals)	123 mm
Net weight	3.8 kg
Mounting position (see note 2)	any

Environmental

Operating temperature range	+10 to +40 °C
Storage temperature	-10 to +50 °C
Shock and vibration	see note 3
Cooling	see note 4

RATINGS AND CHARACTERISTICS

Input

	Min	Max	
Input voltage (see note 1)	95	253	V ac
Input frequency	47	63	Hz
Power consumption	-	50	VA
Trigger input:			
electrical (see note 5)	5	30	V
optical	see Fig. 4 and note 6		
Trigger input impedance	450	-	Ω
Trigger input frequency (see note 7)	-	1	kHz
Trigger input pulse duration	1	100	μ s

Output

Grid 1 output voltage (see notes 8 and 9)	500	-	V
Grid 1 output current (peak) (see note 10)	-	45	A
Grid 1 output impedance (includes 5 Ω fitted internally)	6.0	7.0	Ω
Grid 1 output pulse duration (see note 11)	0.5	0.8	μ s
Grid 2 output voltage (see notes 8 and 9)	1000	-	V
Grid 2 output current (peak)	-	10	A
Grid 2 output impedance (includes 47 Ω fitted internally)	75	85	Ω
Grid 2 output pulse duration (see note 11)	0.40	0.55	μ s
Grid 2 output rate of rise of voltage (see note 12)	5	-	kV/ μ s
Grid 2 bias voltage (see note 13)	-90	-155	V
Grid 2 bias current (see note 13)	-	20	mA
Input to grid 1 pulse delay	0.2	0.4	μ s
Input to grid 2 pulse delay	0.7	1.0	μ s
Grid 1 to grid 2 pulse delay	0.5	0.6	μ s
Time delay drift over full temperature range			
	-	25	ns
Input to grid 2 jitter	-	2	ns

NOTES

- The MA2709A has a filtered changeover socket to allow operation with either $115 \pm 10\%$ or $230 \pm 10\%$ V ac mains input. The filter connects the mains earth to the box via a 400 μ H inductor.
- The unit can be fitted in any position. Two metal strips are supplied with the unit; these can be bolted to the back of the case to provide four fixing feet with clearance holes for M5 bolts (see Fig. 3). The operating manual supplied with the unit has full details of methods of fitting.
- The unit has not been tested to known levels of shock and vibration, but is of generally rugged construction. It should not be subjected to undue shock and vibration.
- The ambient temperature close to the unit must be kept within the limits specified. No forced-air or other external cooling is required, but when operating near the maximum temperature, the unit should be positioned so that heat can flow away from the unit by convection or conduction.
- The trigger level should be within the limits quoted; if they are exceeded then possible damage could occur to the unit.
- The optical input pulse is via the 9 mm FSMA style connector. To achieve the best performance, the rise time of the input pulse should be as short as possible; a suitable driver is shown in Fig. 4.
- If the input trigger frequency goes above 1 kHz, the output will stop.
- This is the open circuit voltage.
- Outputs are via SHV BNC sockets. In order to meet the EMC emission requirements, the SHV BNC plugs must be wired with double-screened cable.
- The grid 1 resistor must be set so that the grid 1 current does not exceed the maximum specified for the particular thyratron being triggered.** If this not done, the thyratron may be triggered detrimentally by the grid 1 pre-pulse instead of the grid 2 pulse.
- Measured at 50% pulse amplitude.
- Measured between 10% and 90% amplitude with no load connected.
- The average current drawn from the negative bias supply depends on the operating frequency and the thyratron type. The negative bias supply is generated from a capacitor driven bridge circuit and therefore as the bias current increases, the negative bias voltage falls linearly at 2.5 V/mA.

CONNECTION SCHEMATIC

7657A

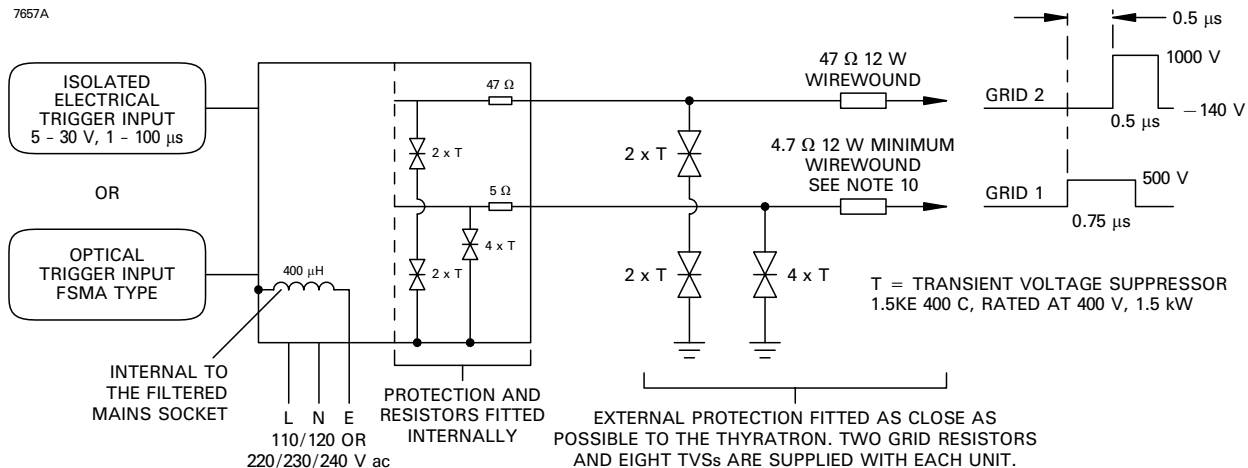

FAULT AND GRID SPIKE PROTECTION

Protection features of the MA2709A:

- Transient Voltage Suppressors (TVSs) fitted internally, together with more TVSs fitted externally close to the thyatron (see above), will protect the MA2709A from thyatron grid spikes. With the external TVS protection circuits fitted, the MA2709A has been shown to withstand a 20 kV, 100 ns long, 20 ns rise time spike at the grid 1 and grid 2 of a thyatron.
- Earthing of the MA2709A is via the coaxial SHV BNC outer braids. The outer terminal of the trigger input BNC socket is also connected to the box and it may be necessary to use a ferrite core to minimise earth currents flowing along the input coaxial cable. See Figs. 1 and 2 for practical earthing considerations when fitting the MA2709A into a circuit.
- The MA2709A will operate continuously into an open circuit.
- The MA2709A will continue to operate if the outputs are short-circuited, but it is not designed to run continuously at full power into a short circuit. The limiting factor is the power rating of the internal grid 1 and grid 2 output resistors.
- The grid 2 negative bias falls to zero if the grid 2 output operates into a short circuit; no internal fuse blows.
- There are three protective fuses: one in the mains input socket to protect against failure of the primary power supply components and one in each of the supply rails to the grid 1 and grid 2 trigger circuits. The latter will blow only if their FET switch fails short-circuit.
- If the input frequency exceeds 1 kHz the output will stop. This prevents the MA2709A being operated in excess of its designed output power level.

EARTHING

It is important to ensure that good electrical practice is followed for earthing the MA2709A so that it is protected from unnecessary earth currents and any resulting voltage spikes. The filtered mains input socket connects the mains earth to the MA2709A metal case via a 400 μ H inductor. Ferrite beads or cores or strip-wound cores can be used to provide effective pulse isolation as indicated in Figs. 1 and 2.

HEALTH AND SAFETY HAZARDS

e2v technologies electronic devices are safe to handle and operate provided that the relevant precautions stated herein are observed. e2v technologies does not accept responsibility for damage or injury resulting from the use of electronic devices it produces. Equipment manufacturers and users must ensure that adequate precautions are taken. Appropriate warning labels and notices must be provided on equipment incorporating e2v technologies devices and in operating manuals.



High Voltage

Equipment must be designed so that personnel cannot come into contact with high voltage circuits. All high voltage circuits and terminals must be enclosed and fail-safe interlock switches must be fitted to disconnect the primary power supply and discharge all high voltage capacitors and other stored charges before allowing access. Interlock switches must not be bypassed to allow operation with access doors open.

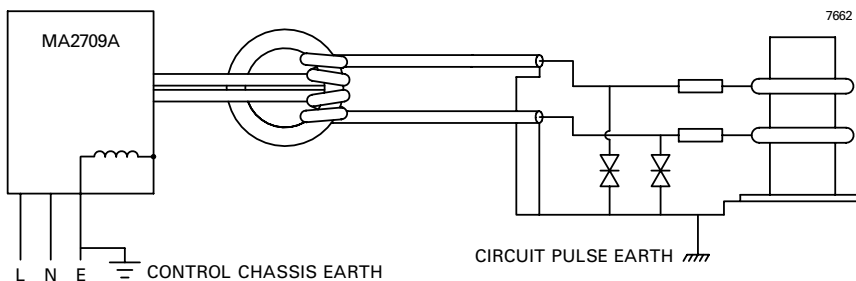

Fig. 1. MA2709A remote from the thyatron discharge circuit

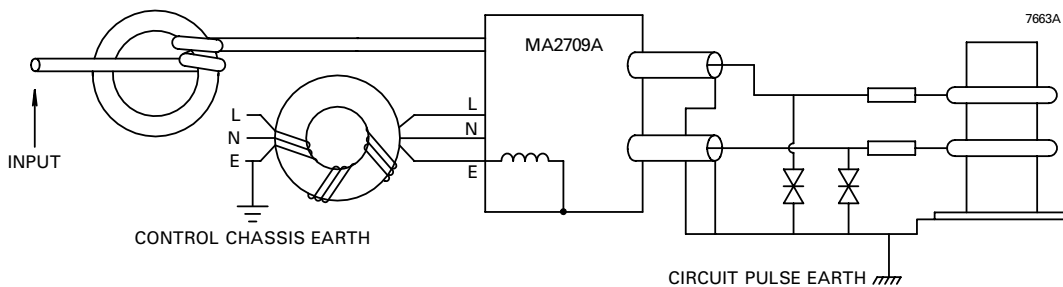

Fig. 2. MA2709A mounted close to the thyatron discharge circuit

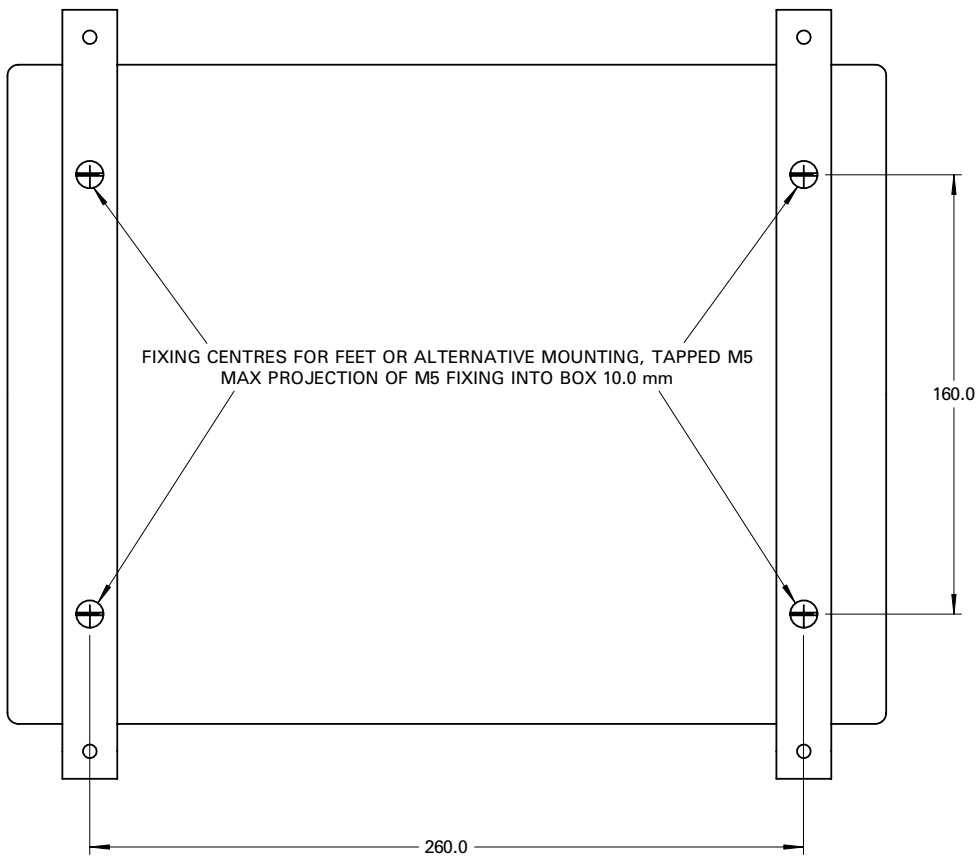
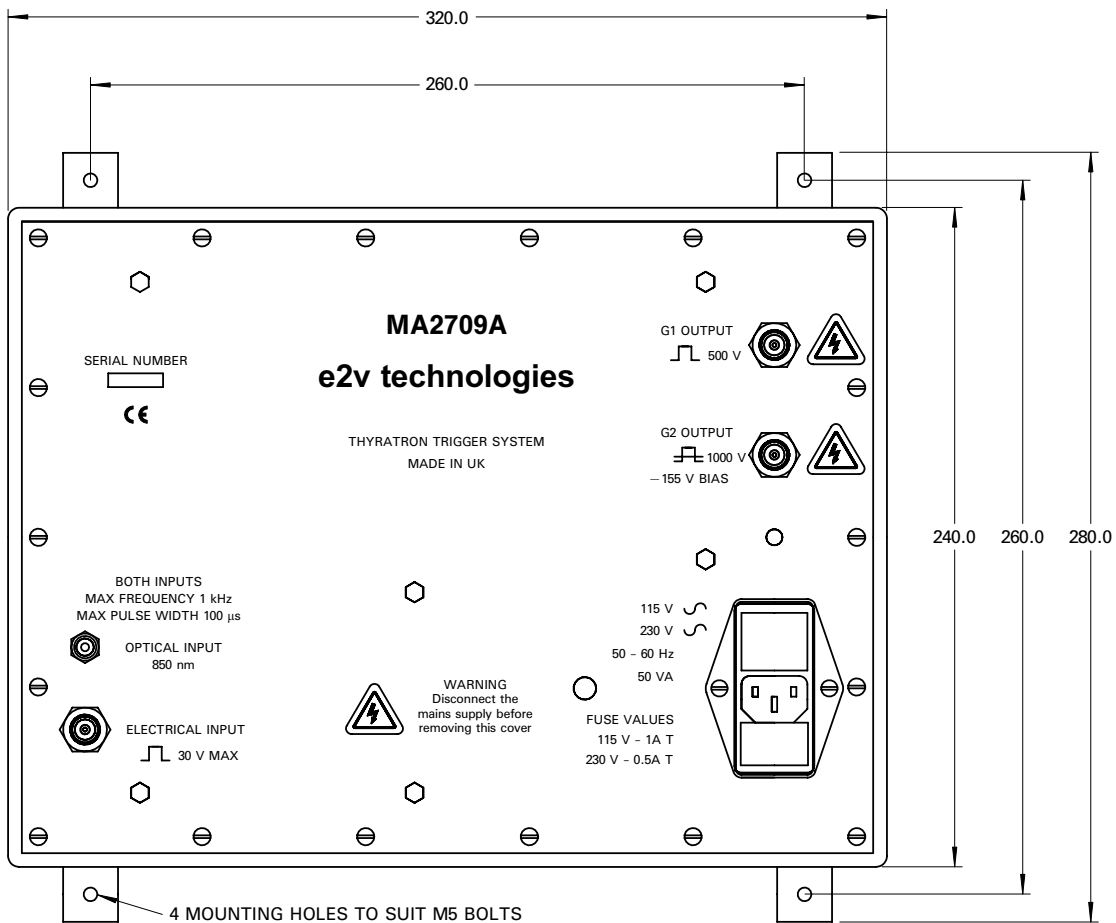
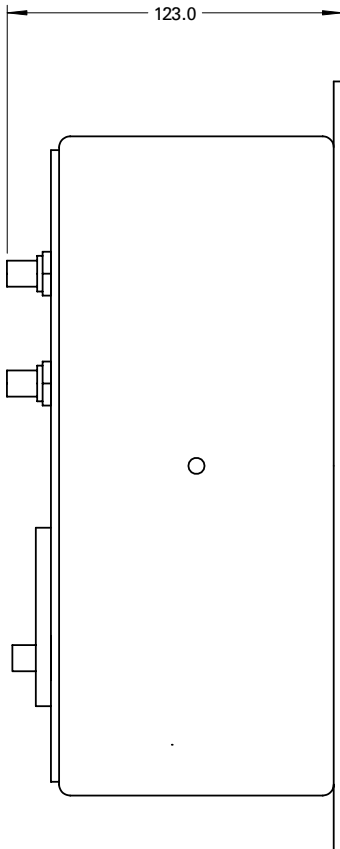

Fig. 3. Box layout and mounting (All dimensions nominal and in millimetres)



STATUTORY AND REGULATORY COMPLIANCE

Low Voltage Directive

This product complies with the requirements of the Low Voltage Directive 73/23/EEC as amended by Directive 93/68/EEC.

Electromagnetic Compatibility

This product complies with the requirements of the Electromagnetic Compatibility Directive 89/336/EEC as amended by Directives 91/263/EEC, 92/31/EEC, 93/68/EEC, 93/97/EEC and 95/54/EEC.

Input Pulse

Amplitude	10	V
Pulse width	1	μ s
Rise time	0.1	μ s

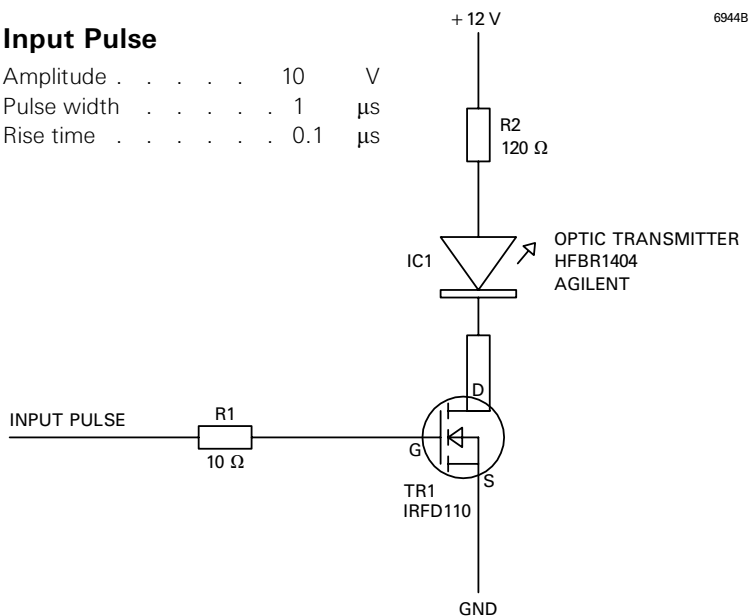

Fig. 4. Suitable drive circuit for optic transmitter

Whilst e2v technologies has taken care to ensure the accuracy of the information contained herein it accepts no responsibility for the consequences of any use thereof and also reserves the right to change the specification of goods without notice. e2v technologies accepts no liability beyond that set out in its standard conditions of sale in respect of infringement of third party patents arising from the use of tubes or other devices in accordance with information contained herein.